

Installation Instructions for: **RIS-STOP-FLOAT-KIT** For RIS-STOP OVERFILL PREVENTION VALVES

(Instructions for flanged & threaded float assemblies)



**ALWAYS USE
NON-SPARK TOOLS!**

PLEASE READ CAREFULLY BEFORE INSTALLATION

ALWAYS USE NON-SPARK TOOLS!

There is also a Vent Body and modified Float Assembly for use where there is no space port for the float assembly to be fitted to:

Ask for RIS-FLANGE2-VENT-AND-FLOAT



ALWAYS USE NON-SPARK TOOLS!

Introduction

The RIS-STOP Range of Overfill Prevention valves are Normally Closed, Failsafe and Testable mechanical tank overfill prevention devices. Dependent on the model they are suitable for gravity and pressure fill deliveries to above and below ground fuel storage tanks. The valves are designed and manufactured for use with Petroleum Spirit and Diesel, including Bio-Fuel Blends.

NB: If use with alternative fuels outside this spectrum is required please refer to Risbridger Ltd.

The RIS-STOP valves are opened by the flow of product being delivered into the tank, and closed against the delivery flow when the float lifts at the preset maximum tank capacity (Normally 95% of Tank Capacity. For details of Installing RIS-STOP Valves please see relevant Installation Instructions.)

Should the float become dislodged or damaged the valve will fail to open to receive fuel into the tank, this indicates a problem with the valve and is it's FAILSAFE mode.

Maintenance is recommended to be carried out on a 12 month period. Testing of the Valve's correct functioning is part of this Maintenance Procedure and is carried out during a delivery, when tank is at least 80% full. Further Testing Operations can be carried out to the owner's or operator's required schedules.

Should the RIS-STOP Valves need servicing or replacement parts please refer to Risbridger Ltd for more information.

Before starting a Maintenance or Testing Operation please make sure you observe the correct Health & Safety Precautions and carry out work with due adherence to Site Specific Regulations

Before starting work ensure you have the following: -

Recommended Installation Tools required for fitting RIS-STOP-FLOAT-KIT(-F)

- Spanners 17mm, 19mm, 1.5inch AF, 1.25inch AF (or adjustable up to 1.5 inch)
- Metric sockets 17mm, 19mm
- Torque wrench
- Thread / O-ring Grease



ALWAYS USE NON-SPARK TOOLS!

INSTALLING A RIS-STOP-FLOAT-KIT ON TO TANK LID.

Before a float kit can be installed onto a tank lid it must be configured as described in [this installation guide](#).

PREPARATION

The tank lid surface (either threaded socket or flange type) should be thoroughly cleaned prior to installation of RIS-STOP-FLOAT-KIT components.

Threaded sockets should be tested with a suitable male thread fitting to ensure there is no binding. Tight threads must be cleared with a thread tap of correct specification:

2in	BSPP Female	(ISO 228-G2)
3in	BSPP Female	(ISO 228-G3)
4in	BSPP Female	(ISO 228-G4)

Likewise with flange fit tank lids, the blind tapping's should be individually and thoroughly cleaned (compressed air if available). Use a dummy bolt to check for full thread engagement without binding.

If required, tight threads should be cleared with a suitable thread tap, refer to bolt table.

Bolt Thread (Male Tap Size)	Recommended Torque Setting	Socket/Spanner Size
M8 x 1.25	20 Nm (15 lbf/ft)	13mm AF
M10 x 1.50	40 Nm (30lbf/ft)	17mm AF
M12 x 1.75	60 Nm (60lbf/ft)	19mm AF

Warning – Do not over tighten bolts especially into alloy body components.

ALWAYS USE NON-SPARK TOOLS!

IN THE BOX

There are two models of float kit as below:

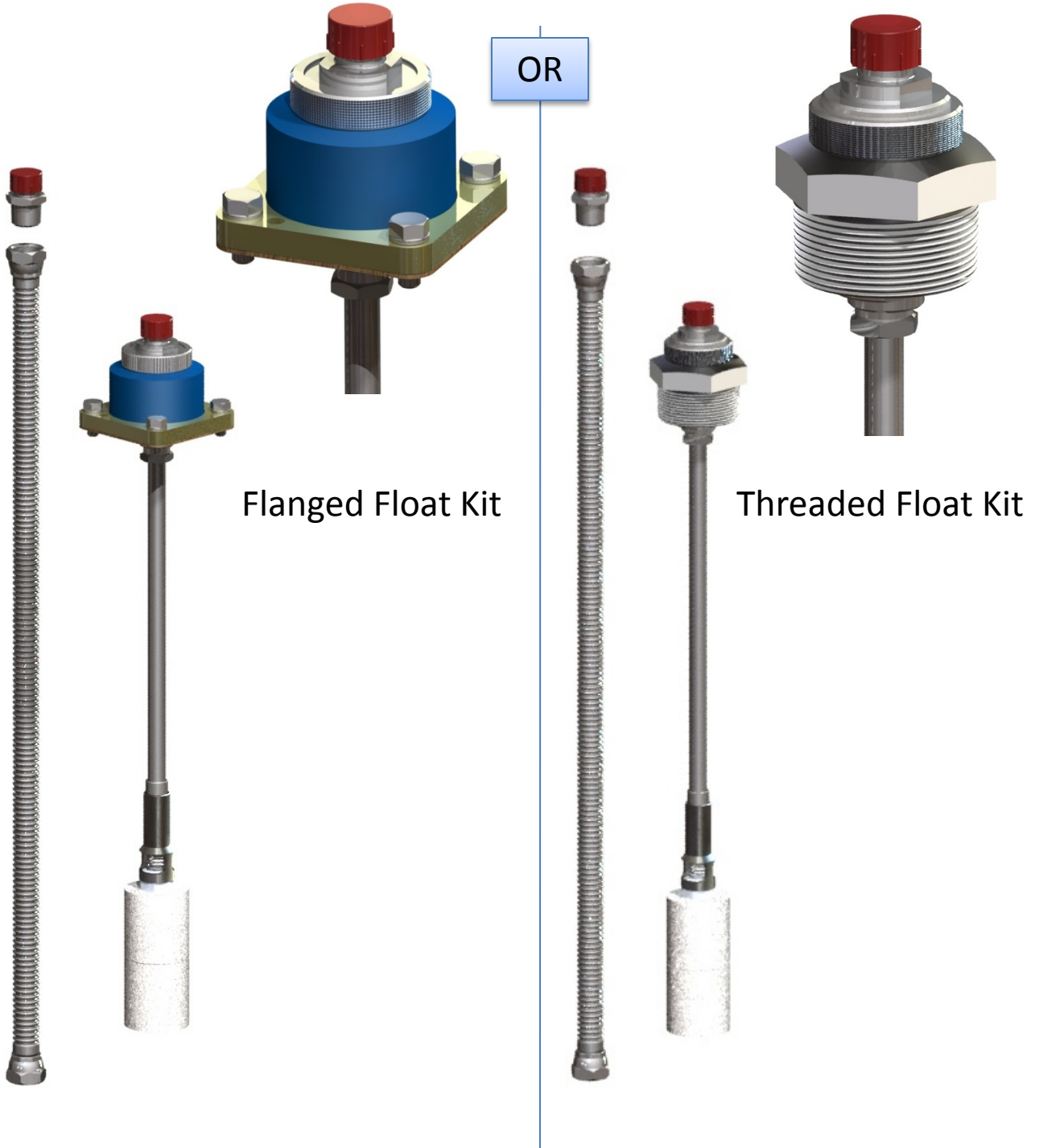

Flanged Float Kit

Threaded Float Kit

ALWAYS USE NON-SPARK TOOLS!

FLOAT CARTRIDGE CONFIGURATION (THREADED VERSION)

Before a float kit is fitted, the float drop tube must first be cut to achieve the correct shut-off activation level (usually 95% of the fuel tank capacity).

The following diagram and calculations guide you through this process.

Note:

The distance between the valve cartridge and float tank lid connections should be less than 350mm (between centres).

The diagrams and calculations are for horizontal cylindrical tanks.

The float activation level is approximately 50% of the foam length (denoted by the split line).

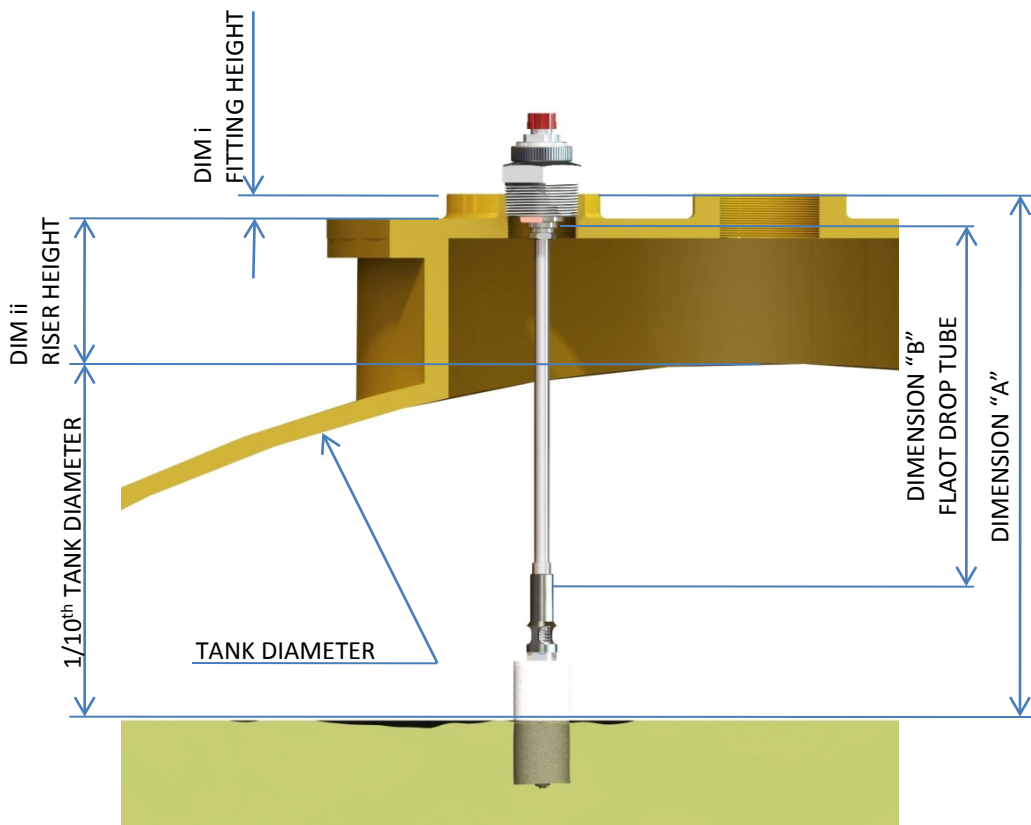

ALWAYS USE NON-SPARK TOOLS!

Calculations:

- Dim "A" = 1/10 of Tank Diameter + Fitting Height (Dim i) + Riser Height (Dim ii).
- Dim "B" = Dim "A" – 135mm.

Example:

Tank Diameter = 2500mm, Dim i = 20mm, Dim ii = 118mm.

- Dim "A" = 250mm + 20mm + 118mm = 388mm
- Dim "B" = 388mm – 135mm = 253mm (Tube to be cut to this length).

ALWAYS USE NON-SPARK TOOLS!

Threaded RIS-STOP-FLOAT-KIT Installation:

These installation instructions are for the THREADED version only, please refer to page 12 for FLANGED variant:

1. Using the calculations on the previous page, cut the drop tube to length at the **non-threaded end** with pipe cutters, ensuring a square and burr-free edge remains. Place the olive clamp nut together with olive over the drop tube as shown.



2. Insert the drop tube with olive assembly into the cartridge as shown. Tighten the clamping nut over the olive to hold the cartridge in situ, ensuring that the olive is properly compressed.

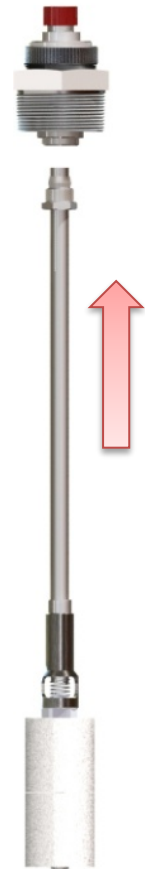
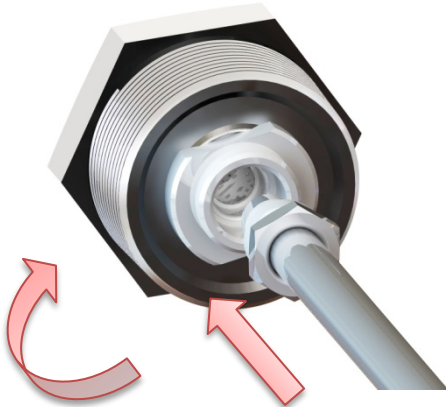

ALWAYS USE NON-SPARK TOOLS!

3. Install the float into the tank lid.
Note: Do not damage the Float as this may result in malfunction of the RIS-STOP valve.

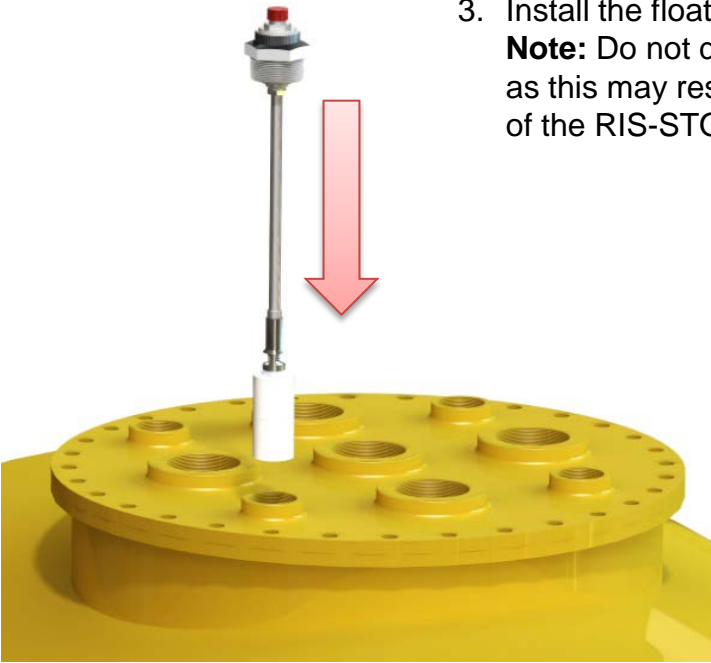

4. When installed the top of float assembly will sit slightly proud of the tank-lid socket. See illustration on right.



ALWAYS USE NON-SPARK TOOLS!

FLOAT CARTRIDGE CONFIGURATION (Flanged Version)

Before fitting, the float assembly must be cut to length to achieve the correct shut-off activation level (usually 95% of the fuel tank capacity).

Please use the following diagram and formula to calculate the correct length.

Note:

The distance between the valve cartridge and float tank lid connections should be less than 350mm (between centres).

The diagrams and calculations are for cylindrical horizontal tanks.

The float activation level is approximately 50% of the foam length (denoted by the split line).

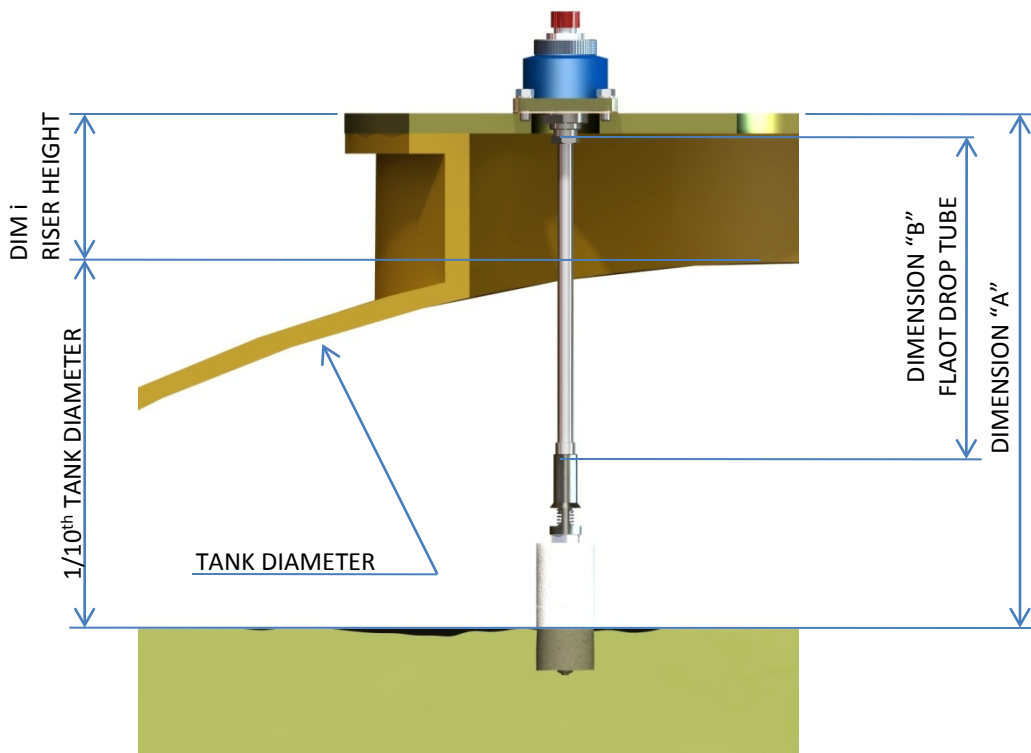

ALWAYS USE NON-SPARK TOOLS!

Calculations:

- Dim "A" = 1/10 of Tank Diameter + Riser Height (Dim i) + Adaptor Thickness (Dim ii).
(Optional)
- Dim "B" = Dim "A" – 125mm.

Example:

Tank Diameter = 2500mm, Dim i = 118mm, (Dim ii = 16mm, Optional)

- Dim "A" = 250mm + 118mm + 16mm = 384mm
- Dim "B" = 384mm – 125mm = 259mm (Tube to be cut to this length).

ALWAYS USE NON-SPARK TOOLS!

RIS-STOP-FLOAT-KIT (FLANGED) Installation.

Instructions for FLANGED version only, refer to page 6 for THREADED variant:

1. Cut the drop tube to the calculated length at the **non-threaded end** with a pipe cutter, ensuring a square cut, then de-burr. Assemble the olive as shown in diagram.

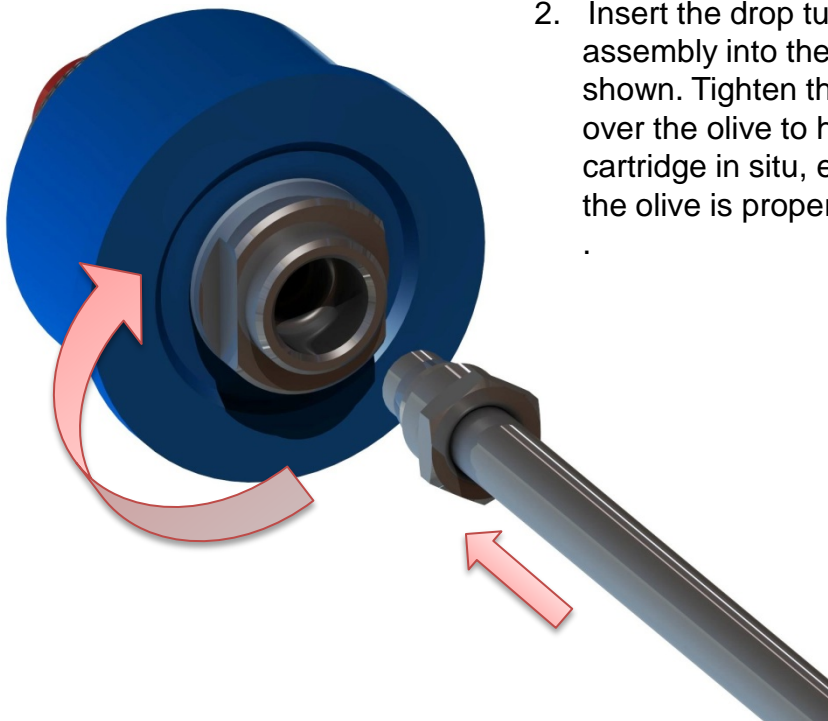

2. Insert the drop tube with olive assembly into the cartridge as shown. Tighten the clamping nut over the olive to hold the cartridge in situ, ensuring that the olive is properly compressed.

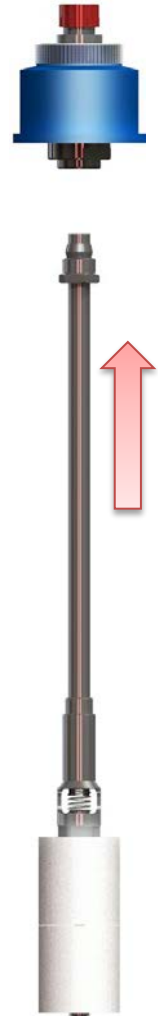

ALWAYS USE NON-SPARK TOOLS!

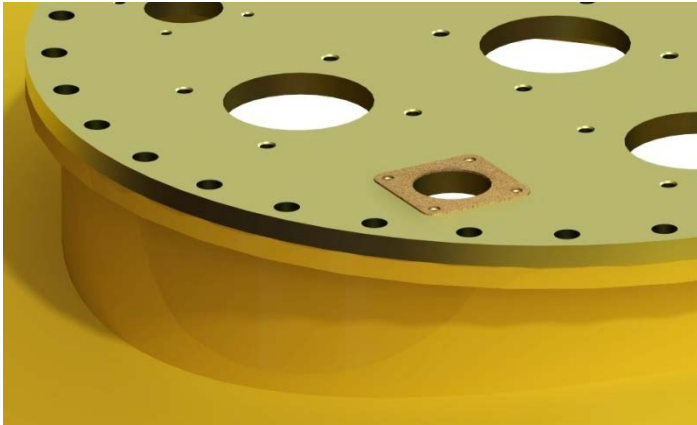

3. Ensure tank lid is free from grease and dirt, then fit gasket over lid port.

4. Install float assembly into the tank lid.

Note: Do not damage the Float during installation as this could result in malfunction of RIS-STOP valve.

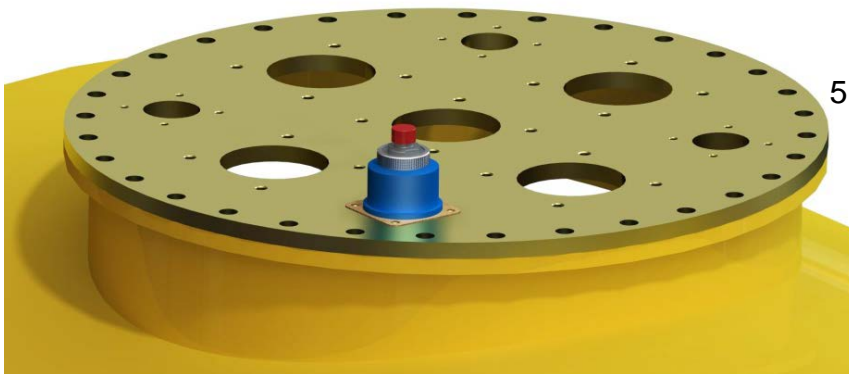
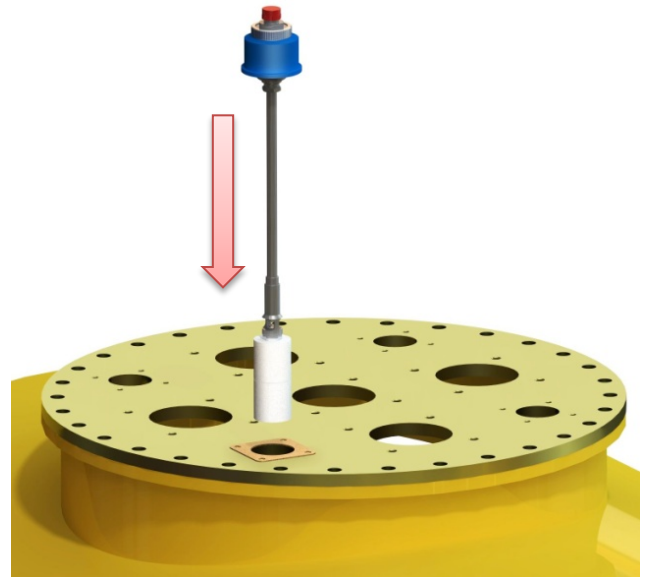

5. Secure the Float assembly in place using 2in flange plate and supplied bolts/washers.

ALWAYS USE NON-SPARK TOOLS!

RIS-STOP-FLOAT-KIT HOSE INSTALLATION. (BOTH VERSIONS)

1. Fit either end of the flexi hose to the float as shown:

Note: Secure cartridge body to prevent it from rotating whilst you tighten hose end fitting.

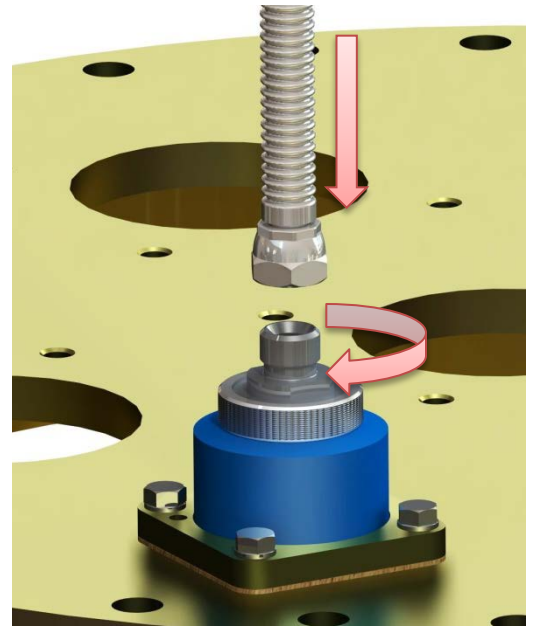

CARE REQUIRED

Apply soft setting thread lock to **this end only** (tapered thread end)

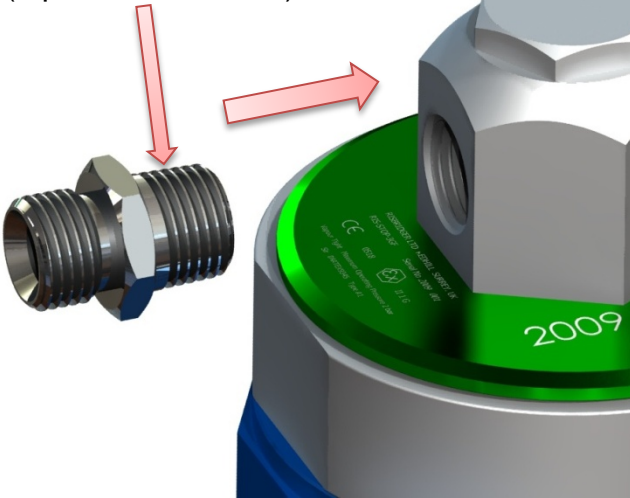

2. Apply soft setting thread lock (GASOILA) onto **tapered end** indicated of the male adaptor and fit to the top of the RIS-STOP hexagon as shown.

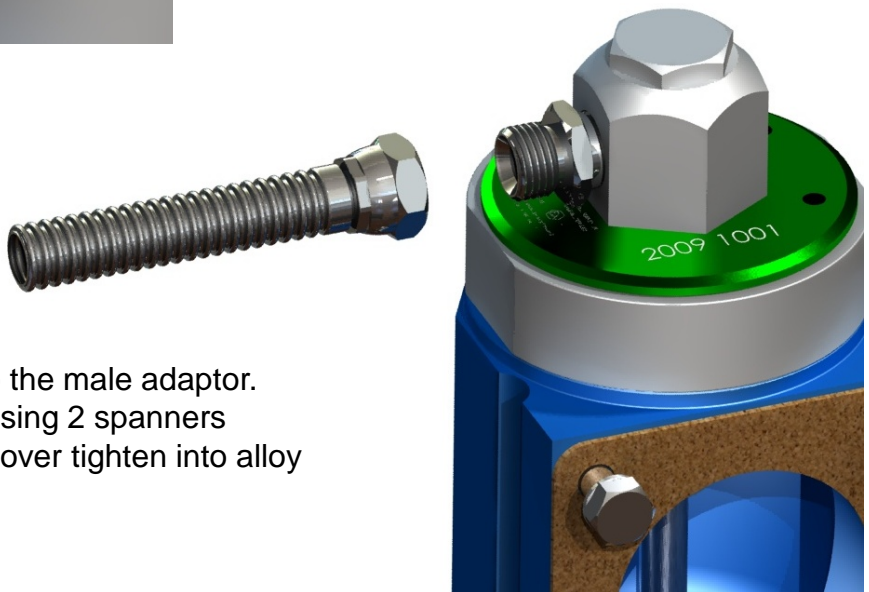

3. Fit flexi hose to the male adaptor. Lock together using 2 spanners ensuring not to over tighten into alloy hex.

ALWAYS USE NON-SPARK TOOLS!

FOR REFERENCE.

Risbridger Ltd offer a range of tools specifically designed for Risbridger products. For further details please contact Risbridger or alternatively, order direct from our website: www.risbridger.com

For installation details of the products supplied with a RIS-STOP Overfill prevention valve and for maintenance instructions, please see documents enclosed with the products or view on our website:

WARRANTY.

All RISBRIDGER Ltd products are guaranteed against defects in material and workmanship for a period of 12 months from the date of purchase subject to normal use and service. The sole obligation under this warranty is limited to repair or replacement, at the option of RISBRIDGER Ltd any product found to be defective upon examination provided that such product will be returned for inspection carriage paid, within three months of installation. Liability is strictly limited to replacement of defective parts manufactured by RISBRIDGER Ltd and no liability can be accepted for any loss or consequential damages arising from the installation or use of any products supplied by RISBRIDGER Ltd whatsoever the cause. This warranty shall not apply to any product subject to abuse, negligence, accident, misapplication or any alteration by others.

ALWAYS USE NON-SPARK TOOLS!

Contact Details:

Risbridger

Quality Engineering Solutions

Risbridger Ltd.
25 Trowers Way,
Holmethorpe Industrial Estate,
Redhill,
Surrey.
RH1 2LH.

Tel: 08456 44 23 23. (8am – 5pm Mon-Fri)

Fax: 08456 44 24 53

Email: info@risbridger.com

Website: www.risbridger.com

UK and Eire Distributor:



Purfleet Forecourt Services Ltd.,
Unit 2-3 Wheaton Court,
Eastern Industrial Estate,
Wheaton Road,
Witham,
Essex.
CM8 3UJ.

Tel: 01376 535260.

Email: trevor.mason@purcom.com

Website: www.pfsfueltec.com

**France, Belgium, Netherlands,
Luxembourg and North Africa
Distributor:**



CGH Belgium NV,
Rijksweg 10C,
B-2280 Bornem,
Belgium

Tel: +32 (0)3 459 80 76

Email: info@cghbelgium.com

Website: www.cghbelgium.com

Document Reference: INS-RIS-STOP-FLOAT-KIT-151130

Risbridger

Quality Engineering Solutions